

Left Elevation

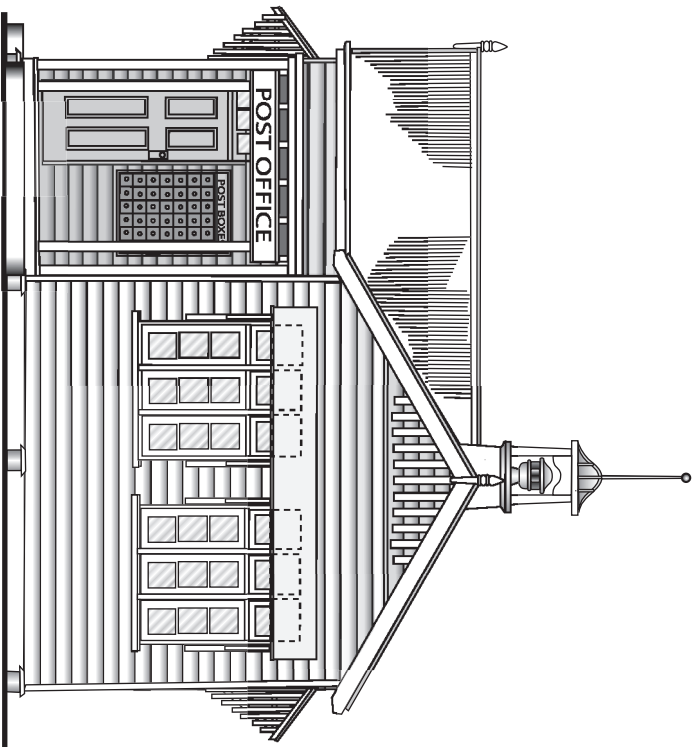

Front Elevation

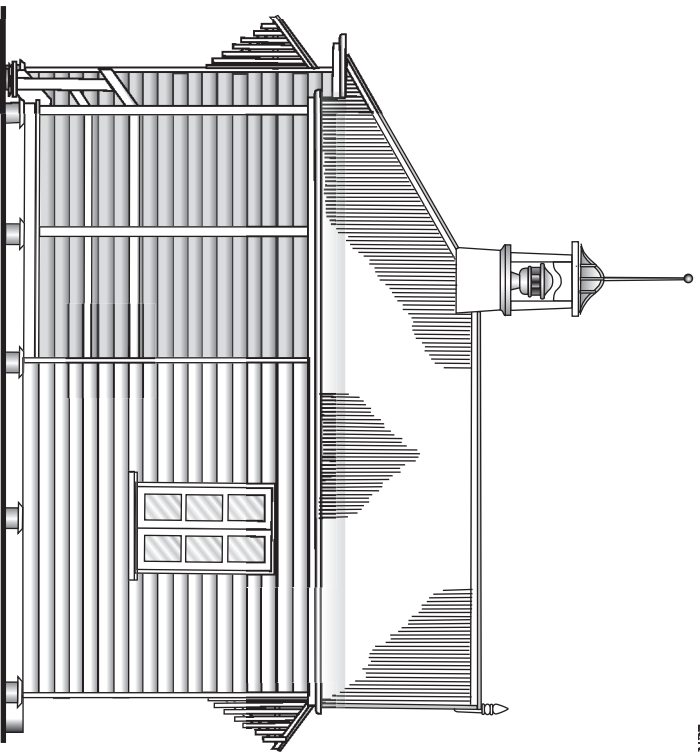

rear elevation

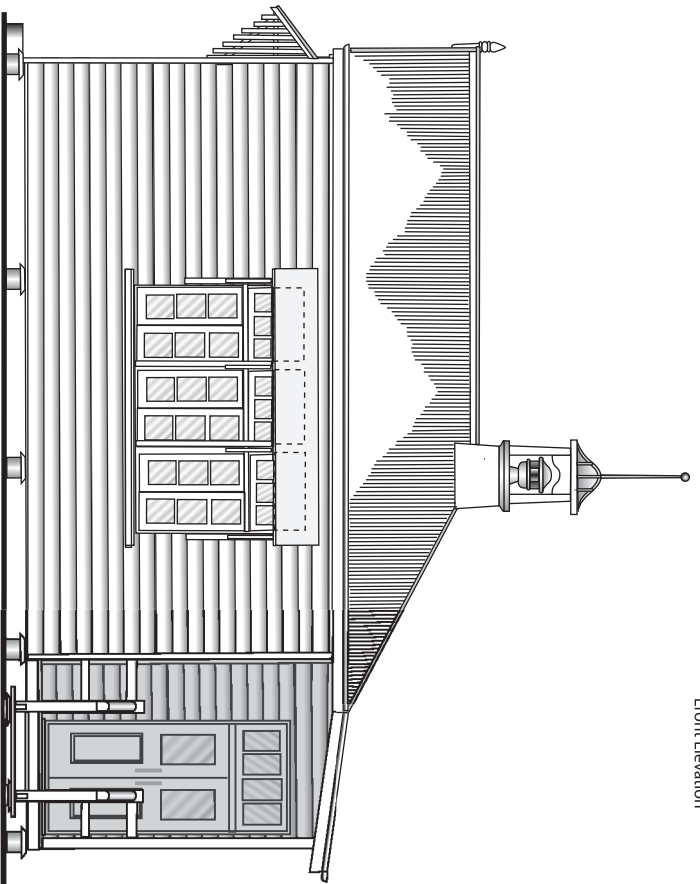

Left Elevation

OAKEY POST OFFICE

Scale 3.5mm = 1 foot

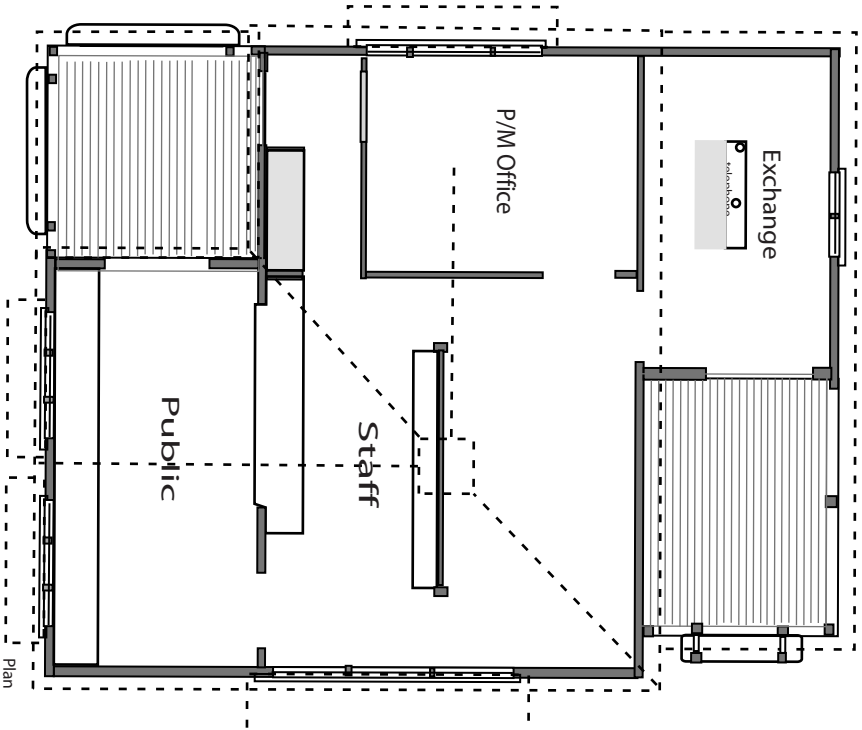

Scale 1/4 inch = 1 foot

# OAKEY POST OFFICE

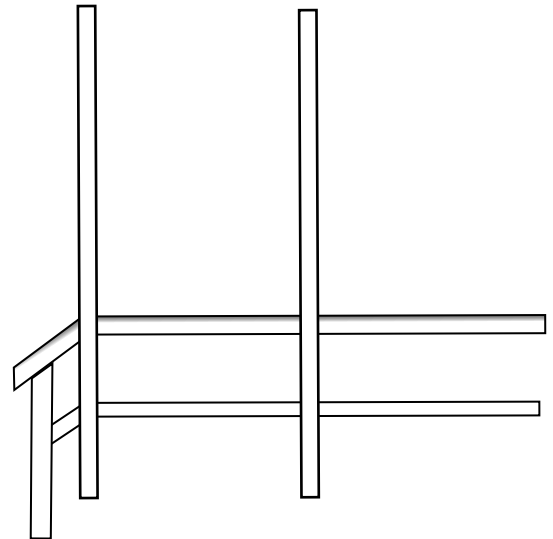
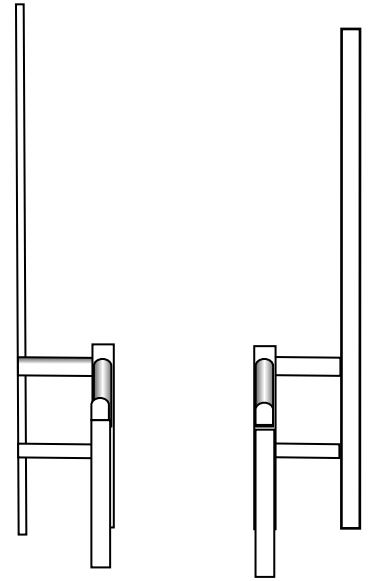
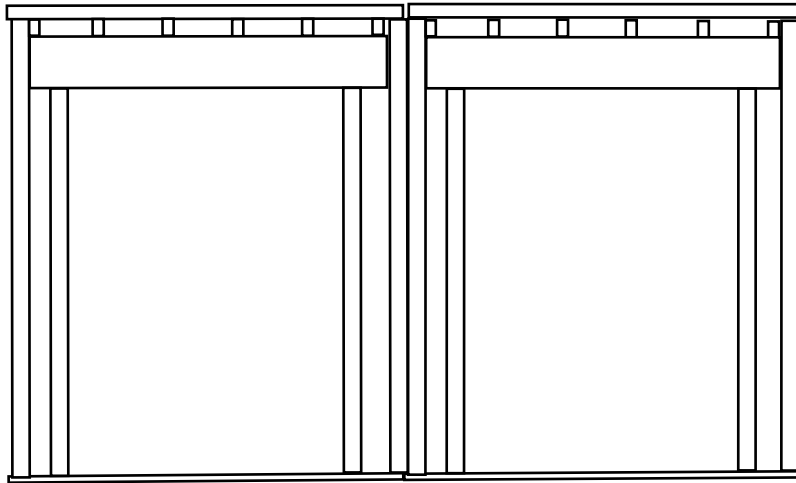

## Post and Handrail Templates

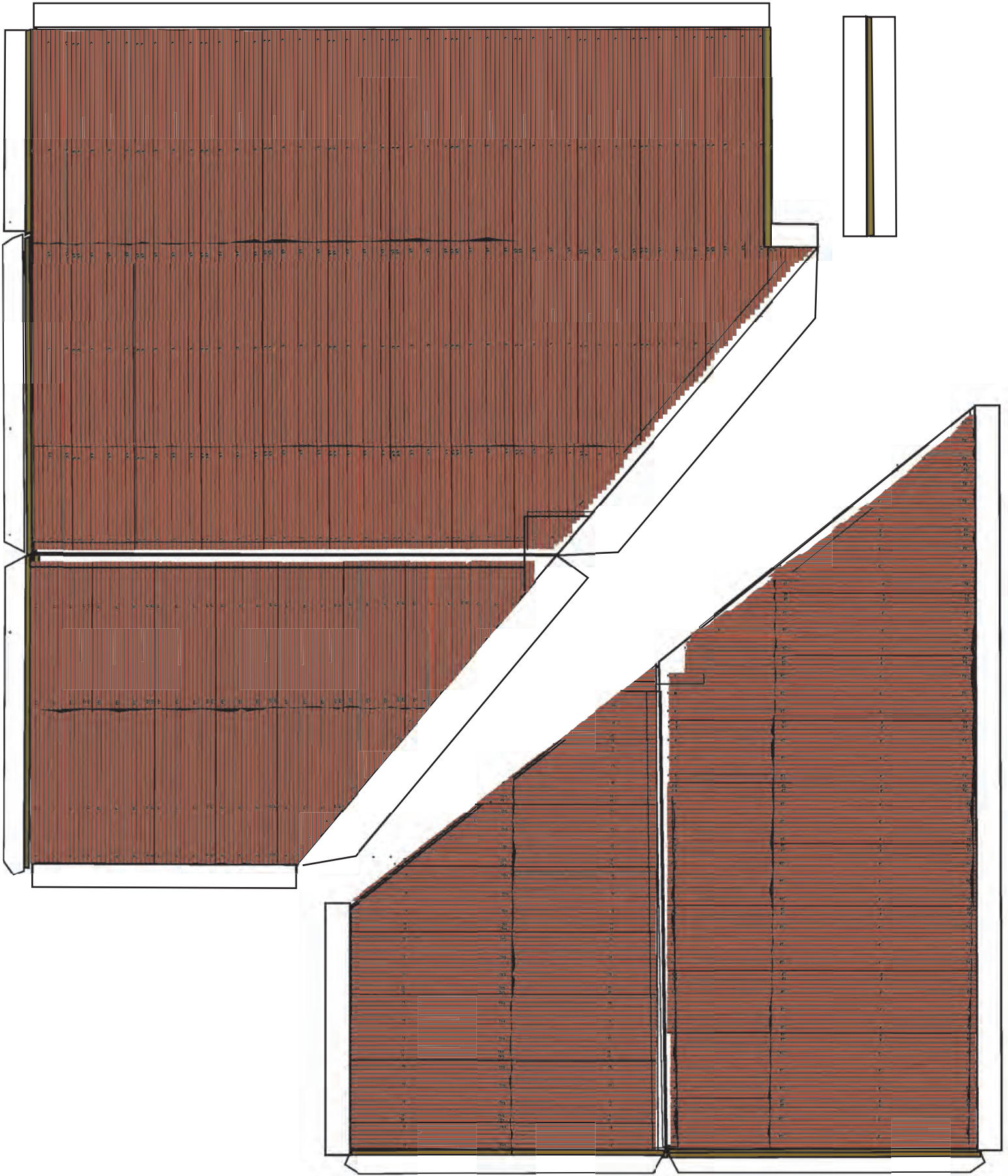

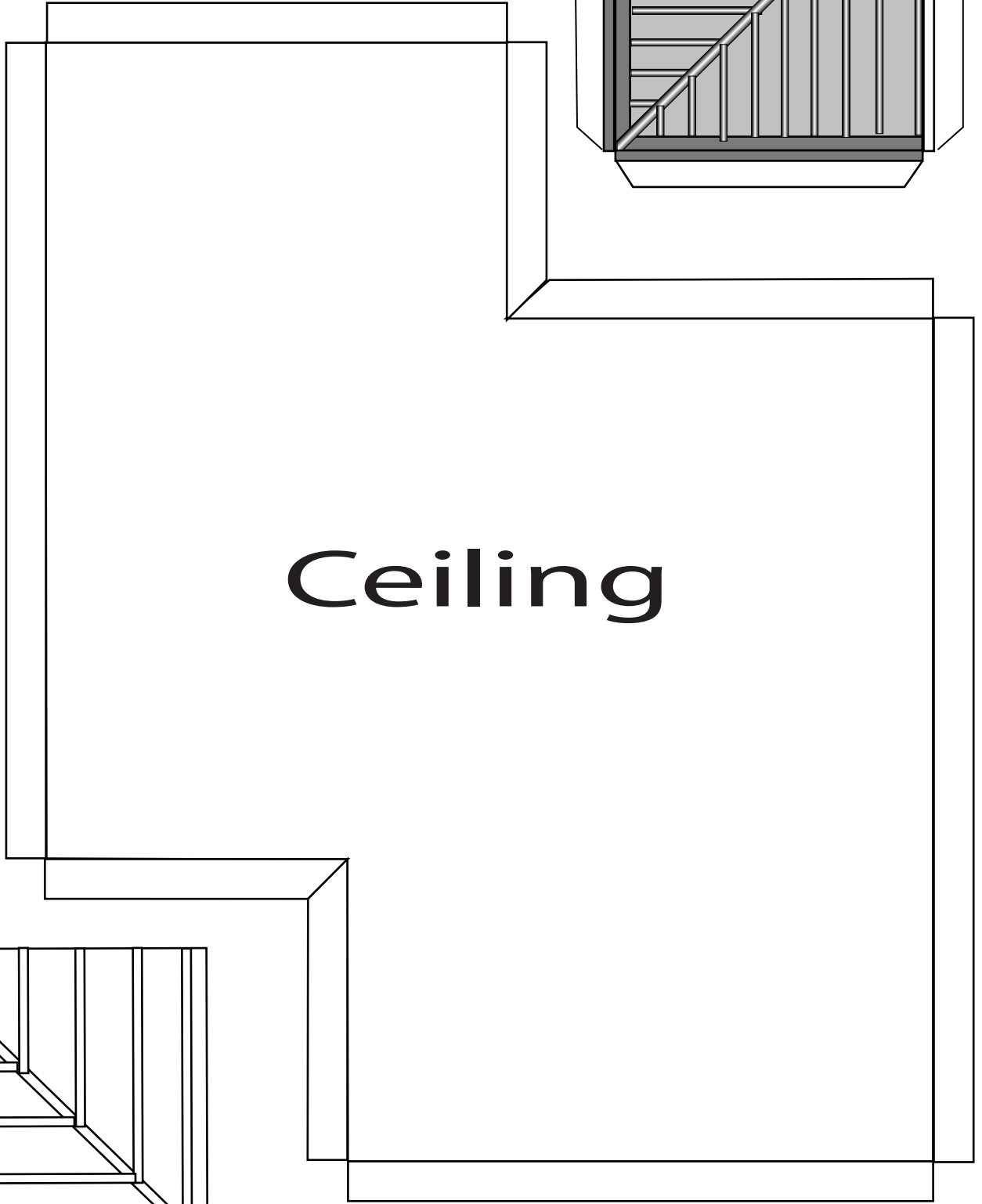
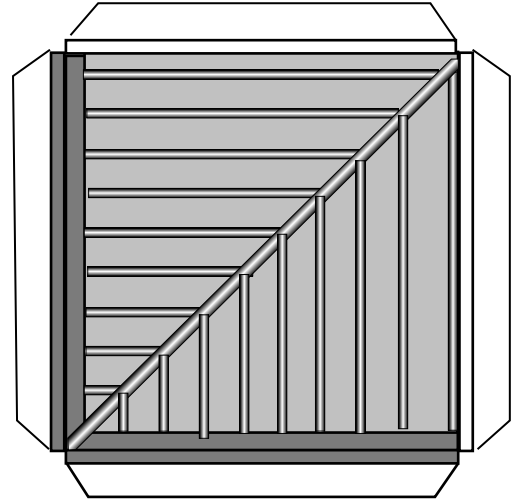

Ceiling

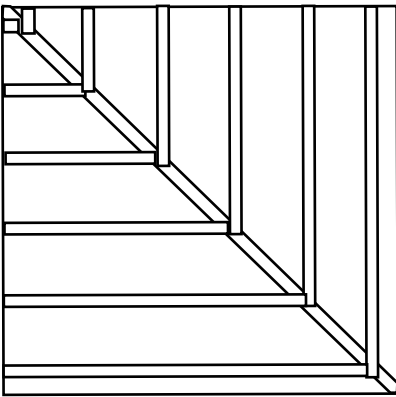

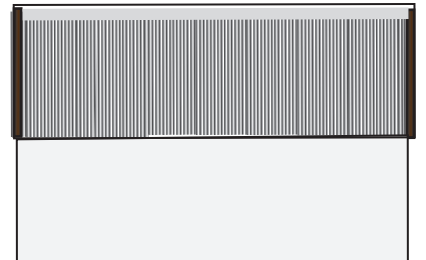
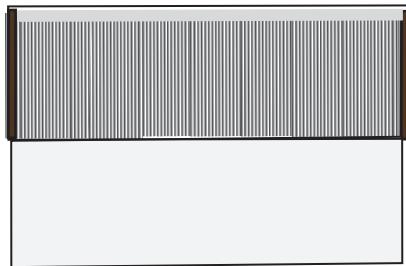
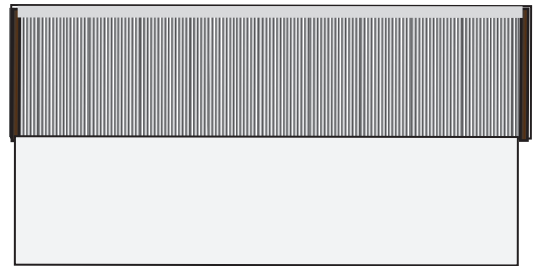
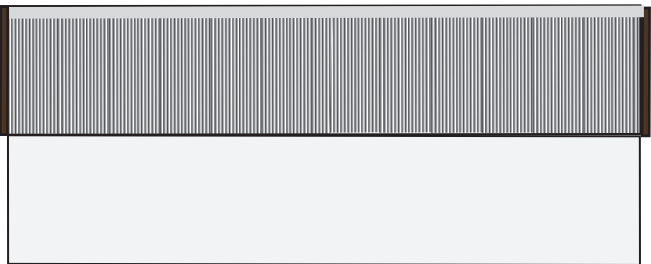
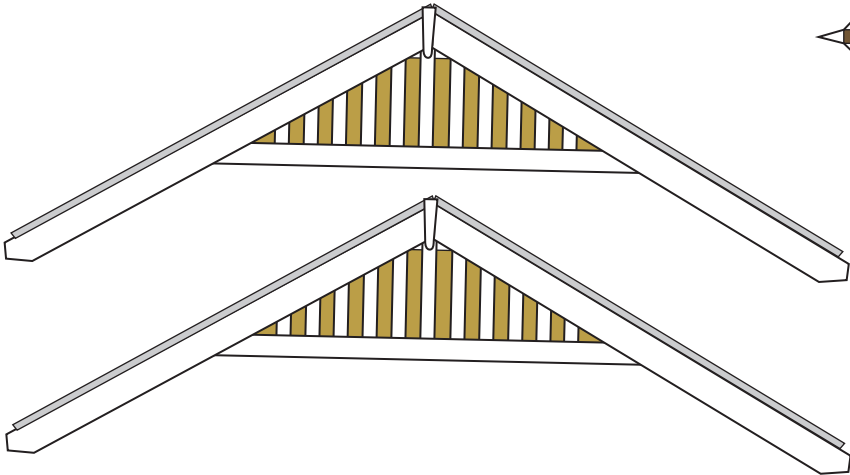
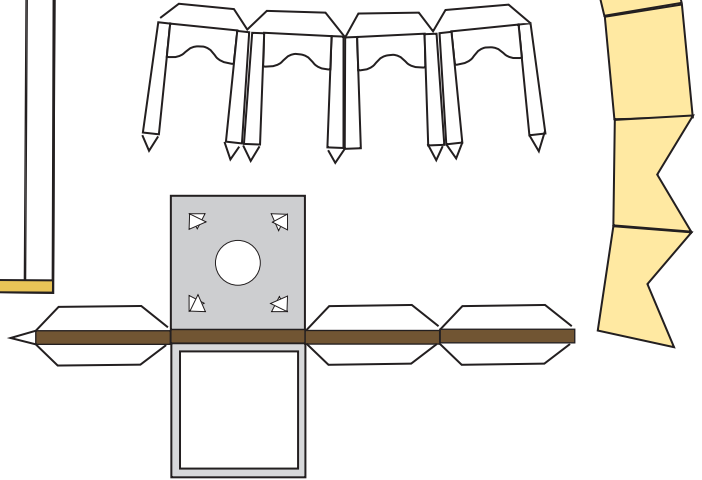
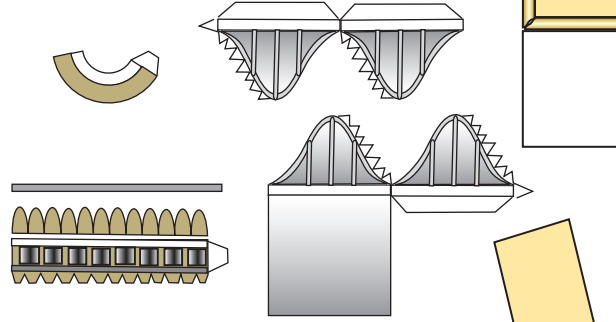
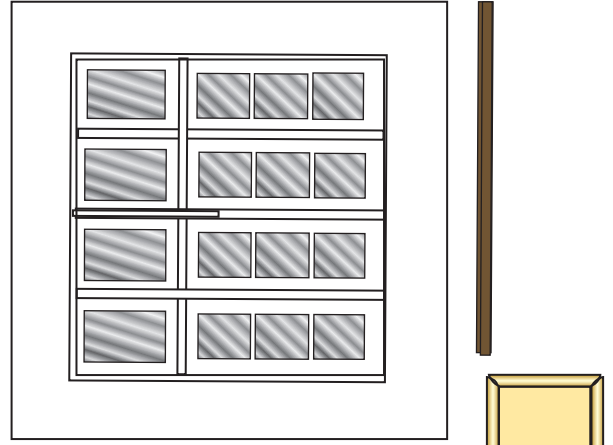
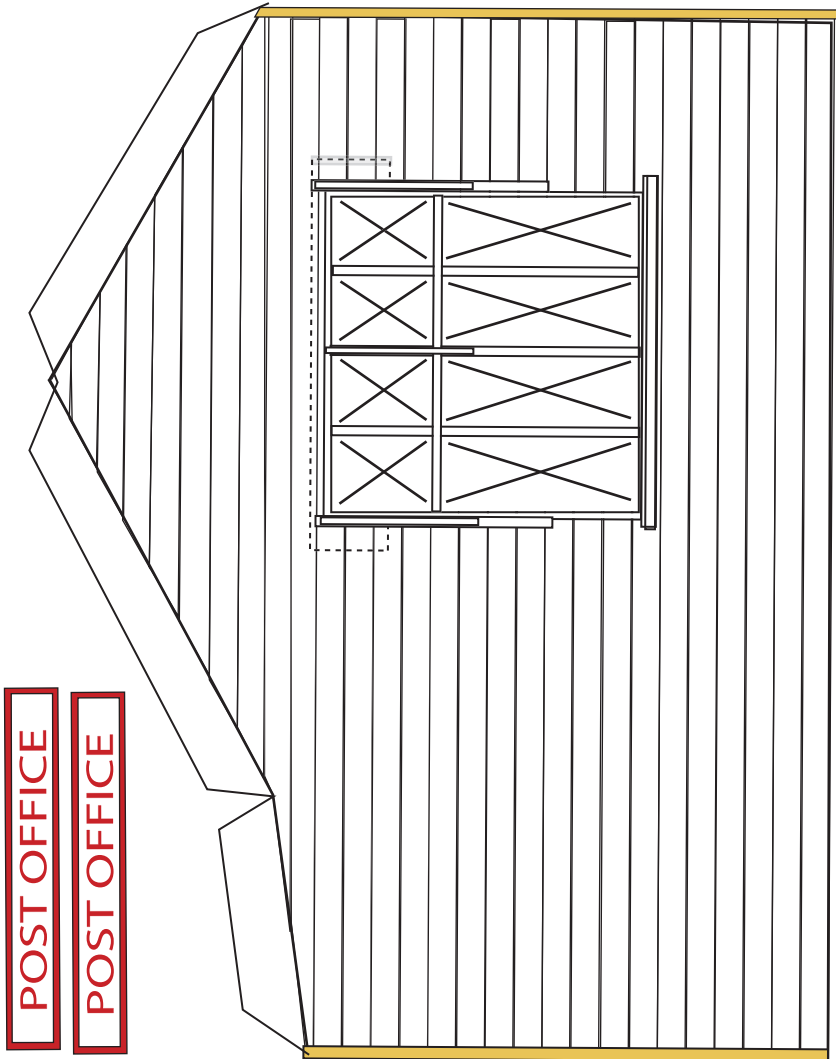

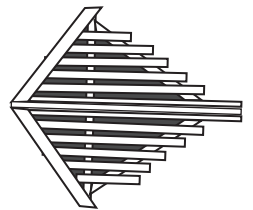
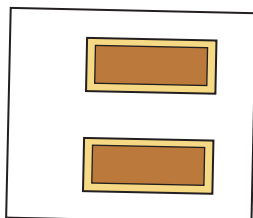
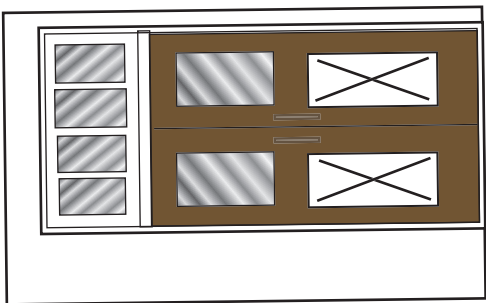
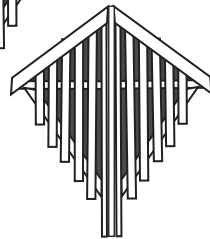
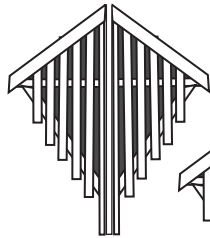
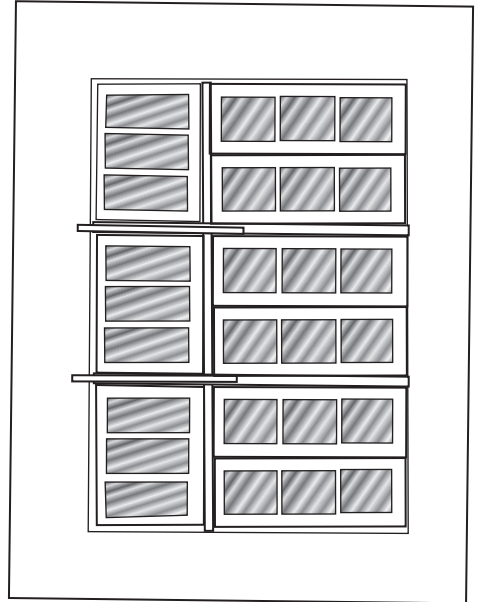
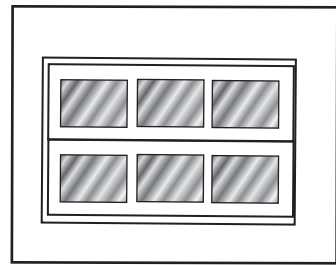
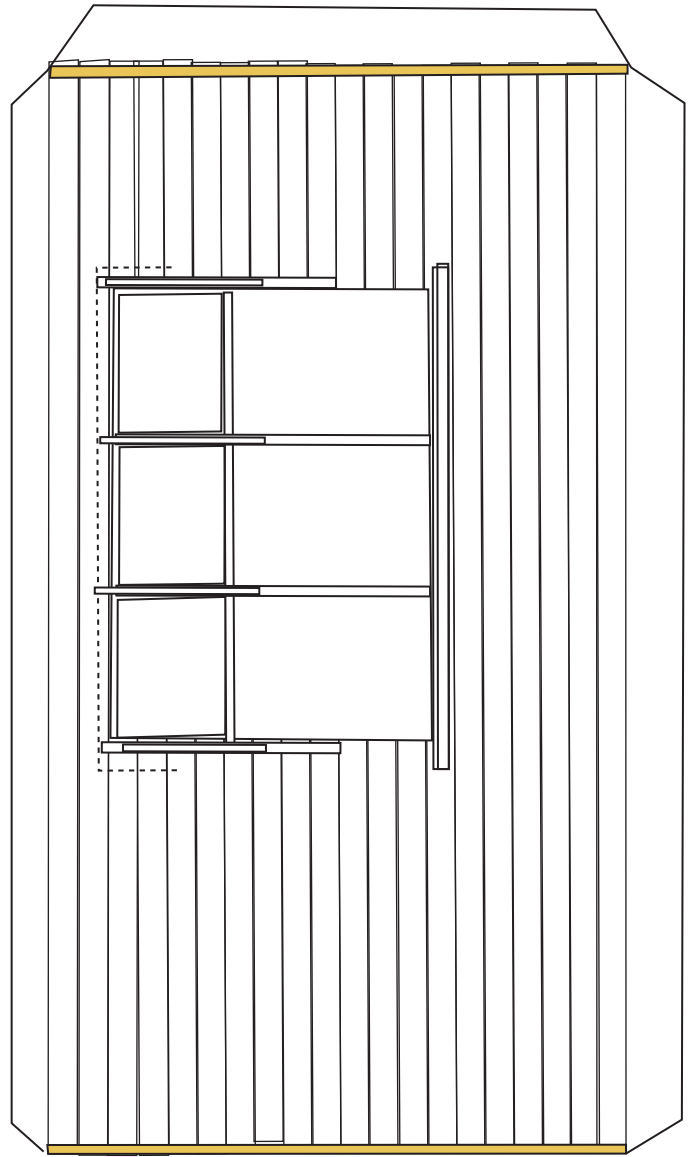
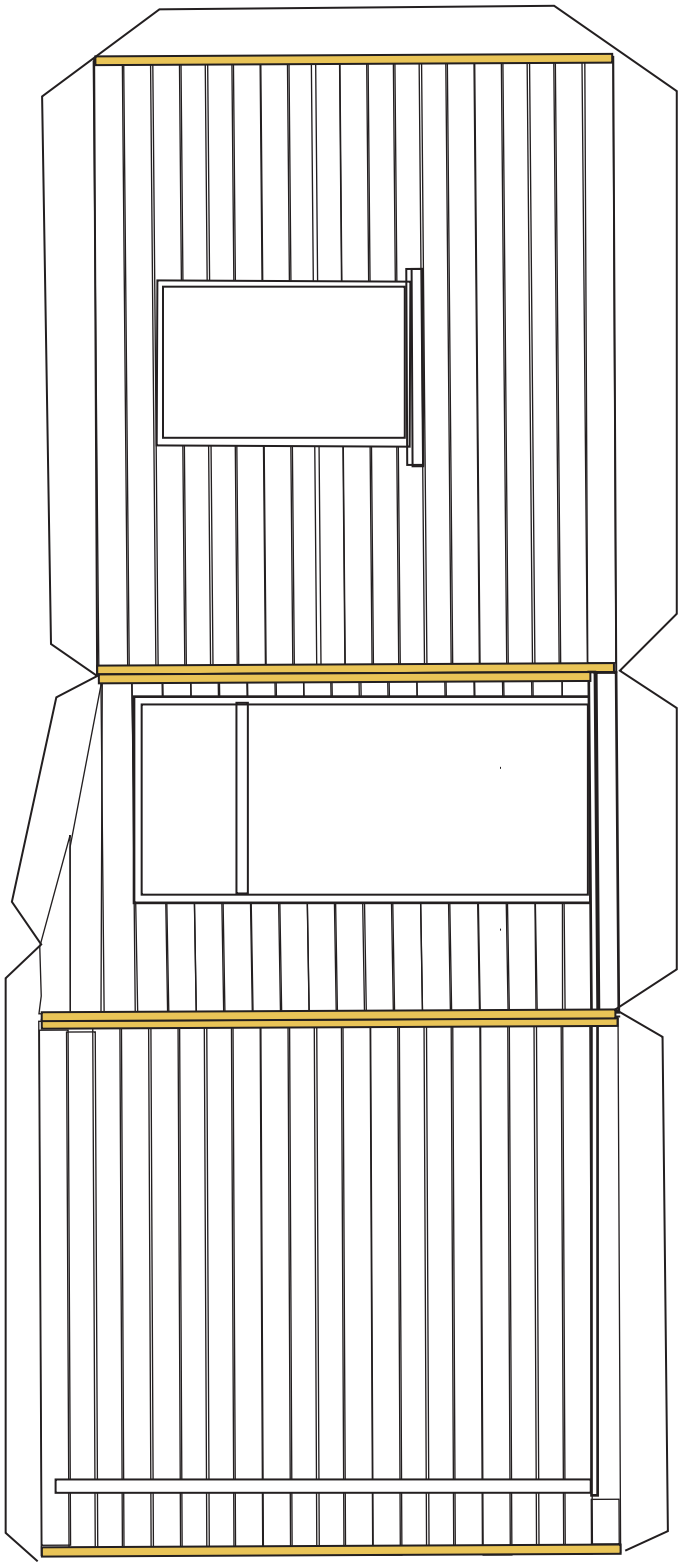



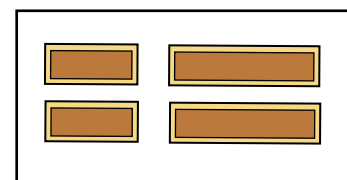
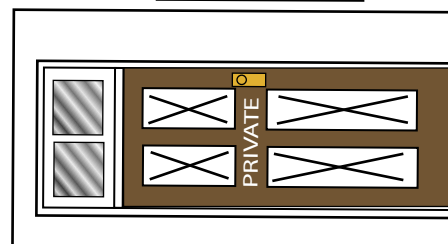
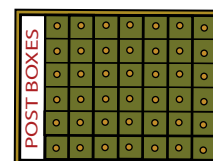
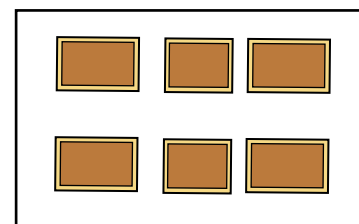
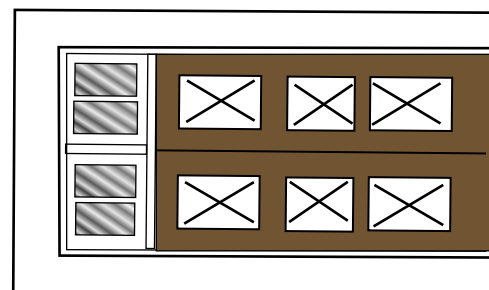
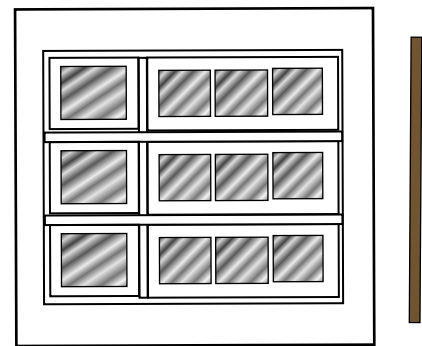
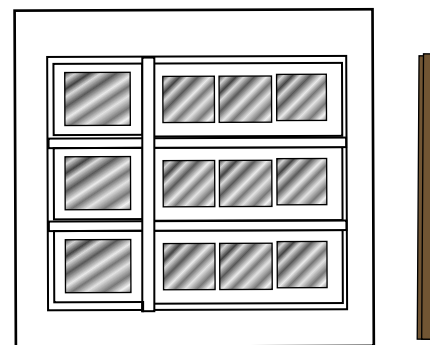
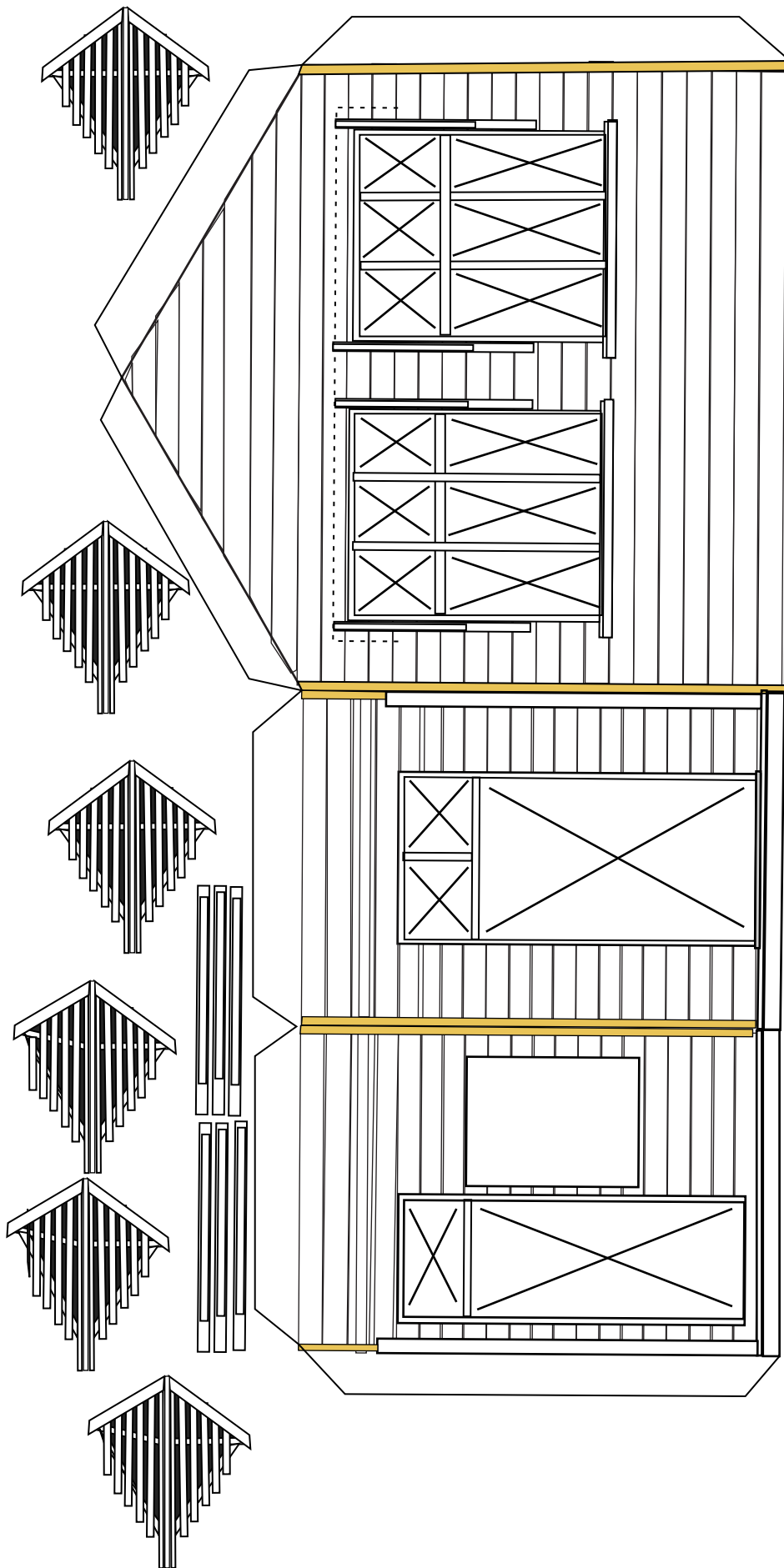



# OAKEY POST OFFICE

"0"Scale

Sheet 2

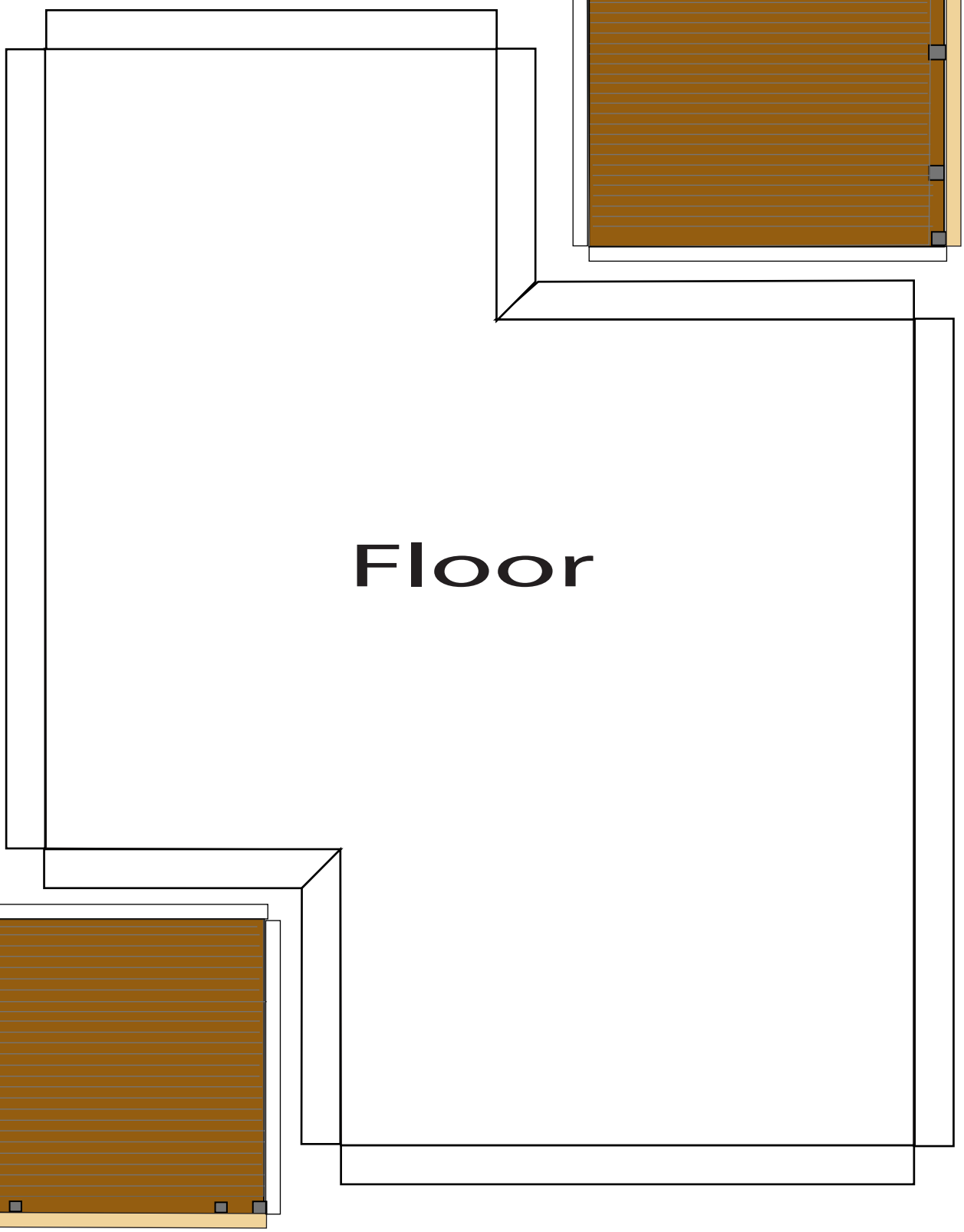
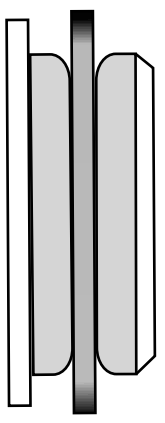
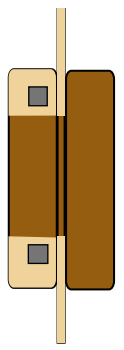
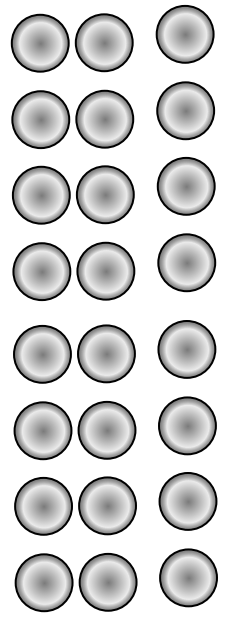
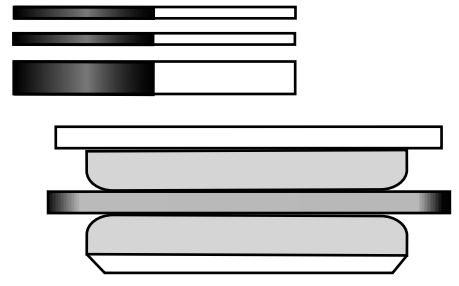
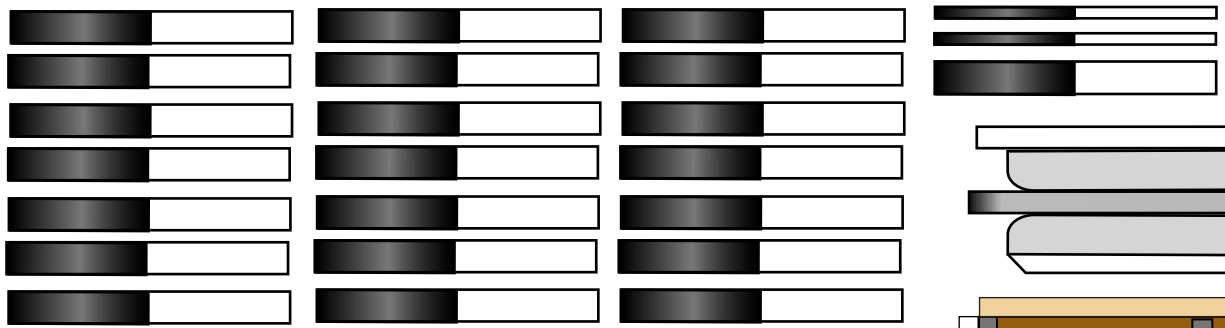

Floor

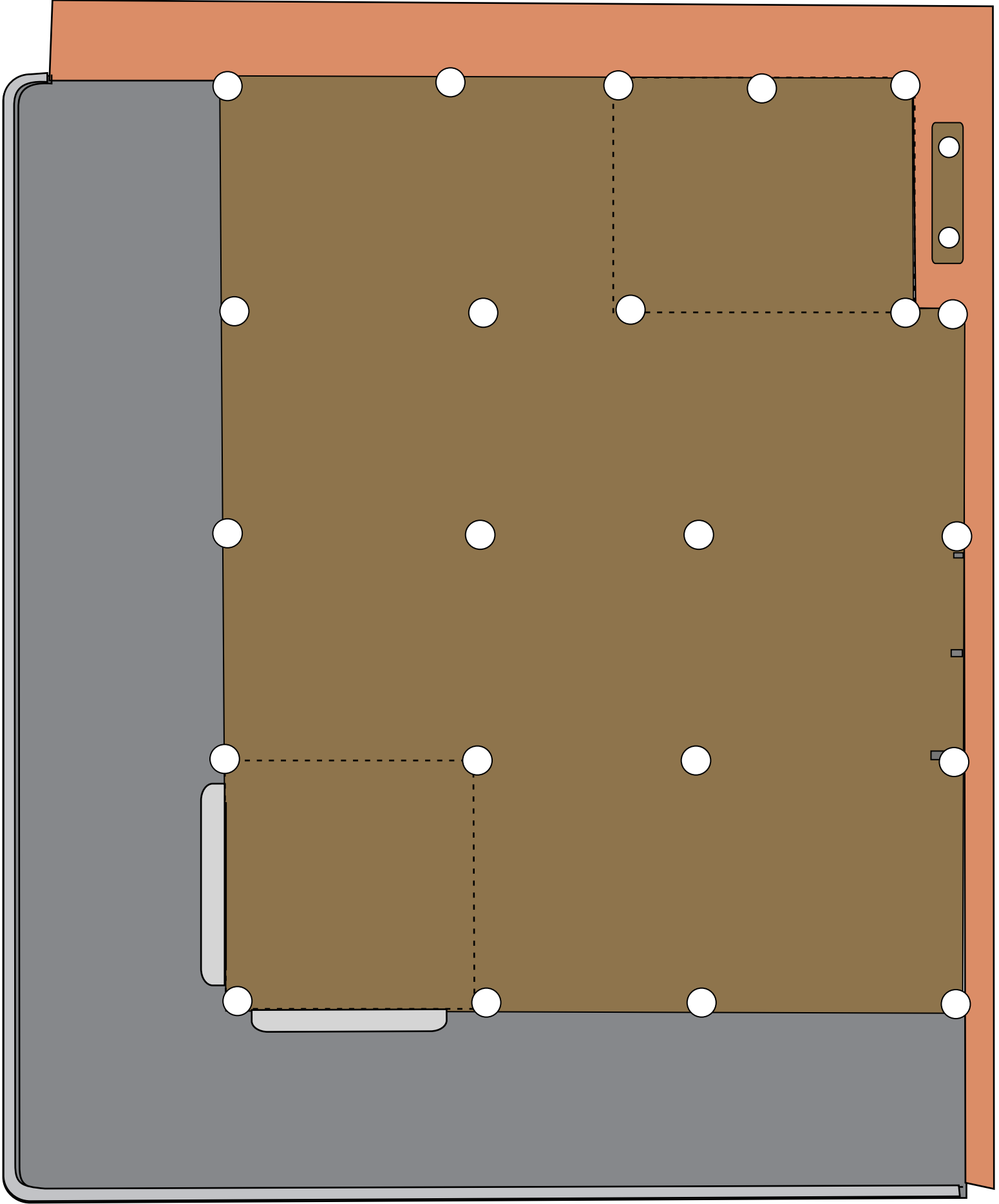

BASE

48 Weatherboards

Dk Stone

